



**TELECRANE ITALIA**  
HIGH PERFORMANCE • WIRELESS TECHNOLOGY

03.2022

# PRODUCTS PRICE LIST





## 2/4 BUTTONS

**Easy Mini F21-2Ss**



2 single speed buttons  
+ stop

**Price: Euro 450,00**  
*Twin: Euro 575,00*

**Hoist F21-4D-2**



2 double speed buttons  
+ start + EMS

**Price: Euro 530,00**  
*Twin: Euro 705,00*

**Tender F21-E2-4**



4 single speed buttons  
+ start + EMS

**Price: Euro 480,00**  
*Twin: Euro 620,00*

**Hoist F21-4D**



4 double speed buttons  
+ start + EMS

**Price: Euro 735,00**  
*Twin: Euro 955,00*

## 6 BUTTONS

**Hoist F21-E1**



6 single speed buttons  
+ start + EMS

**Price: € 735,00**  
*Twin: Euro 955,00*

**Nova F24-8D-6**



6 double speed + start + EMS

**Price: Euro 990,00**  
*Twin: Euro 1305,00*  
*\*with horn*

**Magnum F23-8D-6**



6 double speed buttons  
+ start + EMS

**Price: Euro 1005,00**  
*Twin: Euro 1365,00*

**Top F25-6D**



6 double speed buttons  
+ start + horn + EMS

**Price: Euro 1155,00**  
*Twin: Euro 1545,00*

## 8 BUTTONS

**Tender F21-E2-8**



8 single speed buttons  
+ start + EMS

**Price: Euro 530,00**  
*Twin: Euro 690,00*

**Nova F24-8S**



8 single speed buttons  
+ start + EMS

**Price: Euro 790,00**  
*Twin: Euro 1045,00*

**Magnum F23-8D-8**



8 double speed buttons  
+ start + EMS

**Price: Euro 1025,00**  
*Twin: Euro 1365,00*

**Top F25-8D**



8 double speed buttons  
+ horn + start + EMS

**Price: Euro 1210,00**  
*Twin: Euro 1605,00*

## 10/12 BUTTONS

**Nova F24-10S**



10 single speed buttons  
+ start + EMS

**Price: Euro 825,00**  
*Twin: Euro 1100,00*

**Magnum F23-8D-10**



10 double speed buttons  
+ start + EMS

**Price: Euro 1070,00**  
*Twin: Euro 1440,00*

**Top F25-10D**



10 double speed buttons  
+ horn + start + EMS

**Price: Euro 1265,00**  
*Twin: Euro 1655,00*

**Nova F24-12D**



12 double speed buttons  
+ start + EMS

**Price: Euro 1100,00**  
*Twin: Euro 1485,00*

## Joy stick

**Joy Easy F24-60E PLL**



2 joystick 3 speeds +  
1 function button + 2 selectors  
+ start + EMS

**Price: Euro 1455,00**  
*Twin: € 2195,00*

**Joy F24-60S PLL**









2 joystick 5 speeds +  
4 function buttons + 4  
selectors + start + EMS

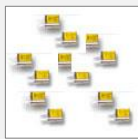

**Price: Euro 1645,00**  
*Twin: Euro 2560,00*

Prices in EURO, VAT not included

# SPECIFIC OPTIONAL

Optional \ model		TENDER	EASY	HOIST	NOVA	MAGNUM	TOP	JOY
<b>Service Kit</b> Including: n.1 bag, n.1 tx, n.1 copier unit, n.1 crystal set, n.2 EMS stop, n.2 start keys, n.1 battery kit, n.3 stickers kit		Euro 397 *no copier	Euro 624	Euro 624	Euro 686	Euro 686	Euro 686	Euro 998 *no crystals
<b>Copier unit</b>		-	Euro 250	Euro 250	Euro 250	Euro 250	Euro 250	Euro 250
<b>Plastic cover for transmitter units 3 pcs kit</b>		Euro 49	Euro 51	Euro 51	Euro 53	Euro 53	Euro 53	-
<b>E-card</b>		Euro 51	-	-	-	-	-	-
<b>Complete set of 7 crystals (ch from 129 to 135)</b>		-	Euro 233	Euro 233	Euro 233	Euro 233	-	-
<b>Complete set of 7 crystals SPECIAL (ch different from 129 to 135)</b>		-	Euro 233	Euro 233	Euro 233	Euro 233	-	-
<b>Stickers kit for transmitter units (3 kinds)</b>		Euro 38	Euro 38	Euro 38	Euro 38	Euro 38	Euro 38	-

# GENERIC OPTIONAL

	Item	Price
	<p>Directional panel sticker</p>	<p>Euro 17</p>
	<p>Frequency counter from 1 MHz to 3 GHz</p>	<p>Euro 363</p>
	<p>Battery charger with n.4 AA rechargeable batteries AC type</p>	<p>Euro 51</p>
	<p>Fixing magnet kit</p>	<p>Euro 12</p>
	<p>USB key with set up software and USB cable</p>	<p>Euro 62</p>
	<p>Passive external antenna with cable</p>	<p>Euro 200</p>

Spare parts pricelist available on request

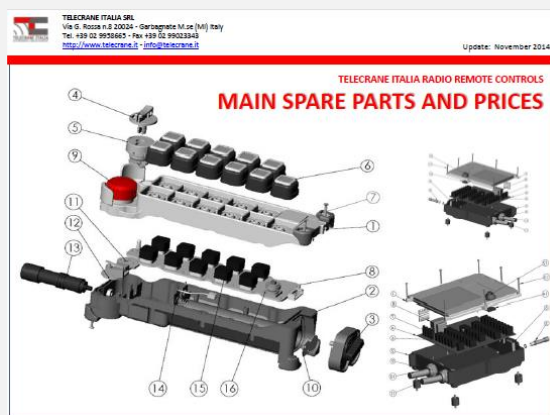

# 2/4 BUTTONS + START & STOP

## Easy Mini F21-2Ss



2 single speed + stop

**Price: € 450,00**

*Twin: € 575,00*

### Power supply

- ✓ 12-24 V DC
- ✓ 24-48 V AC
- ✓ 48-110 V AC
- ✓ 48-220 V AC

### Main features

- ✓ 2 single speed buttons
- ✓ Key with magnet

### Standard equipment

- ✓ n. 2 batteries
- ✓ Receiver wired cable 1.5m
- ✓ Protective plastic cover
- ✓ Shoulder belt
- ✓ Spare fuses
- ✓ Dedicated package

### Documentation

- ✓ EC certificate
- ✓ Test report
- ✓ User's manual
- ✓ Electric diagram
- ✓ CD Rom

## Hoist F21-4D-2



2 double speed + start + EMS

**Price: Euro 530,00**

*Twin: Euro 705,00*

### Power supply

- ✓ 12-24 V DC
- ✓ 24-48 V AC
- ✓ 48-110 V AC
- ✓ 48-220 V AC

### Main features

- ✓ 2 double speed buttons
- ✓ Emergency stop class 3
- ✓ Start button

### Standard equipment

- ✓ Battery charger
- ✓ n.2 AA rechargeable batteries
- ✓ Spare batteries
- ✓ Receiver wired cable 2.5m
- ✓ Protective plastic cover
- ✓ Shoulder belt
- ✓ Receiver fixing kit
- ✓ Spare fuses
- ✓ Dedicated package

### Documentation

- ✓ EC certificate
- ✓ Test report
- ✓ User's manual
- ✓ Electric diagram
- ✓ CD Rom

## Tender F21-E2-4



4 single speed + start + EMS

**Price: Euro 480,00**

*Twin: Euro 620,00*

### Power supply

- ✓ 12-24 V DC
- ✓ 24-48 V AC
- ✓ 48-110 V AC
- ✓ 48-220 V AC

### Main features

- ✓ 4 single speed buttons
- ✓ Removable start key
- ✓ E-Card
- ✓ Copier function

### Standard equipment

- ✓ n.2 batteries AA
- ✓ Receiver wired cable 1.5m
- ✓ Protective plastic cover
- ✓ Shoulder belt
- ✓ Spare fuses
- ✓ Dedicated package

### Documentation

- ✓ EC certificate
- ✓ Test report
- ✓ User's manual
- ✓ Electric diagram
- ✓ CD Rom

## Hoist F21-4D



4 double speed + start + EMS

**Price: Euro 735,00**

*Twin: Euro 955,00*

### Power supply

- ✓ 12-24 V DC
- ✓ 24-48 V AC
- ✓ 48-110 V AC
- ✓ 48-220 V AC

### Main features

- ✓ 4 double speed buttons
- ✓ Emergency stop class 3
- ✓ Start button



### Standard equipment



- ✓ Battery charger
- ✓ n.2 AA rechargeable batteries
- ✓ Spare batteries
- ✓ Receiver wired cable 2.5m
- ✓ Protective plastic cover
- ✓ Shoulder belt
- ✓ Receiver fixing kit
- ✓ Spare fuses
- ✓ Dedicated package



### Documentation



- ✓ EC certificate
- ✓ Test report
- ✓ User's manual
- ✓ Electric diagram
- ✓ CD Rom

# 6 BUTTONS + START & STOP

 <b>Hoist F21-E1</b>	Power supply	Main features	Standard equipment	Documentation
 <p>6 single speed + start + EMS</p> <p><b>Price: € 735,00</b> Twin: € 955,00</p>	<ul style="list-style-type: none"> <li>✓ 12-24 V DC</li> <li>✓ 24-48 V AC</li> <li>✓ 48-110 V AC</li> <li>✓ 48-220 V AC</li> </ul>	<ul style="list-style-type: none"> <li>✓ 6 single speed buttons</li> <li>✓ Emergency stop class 3</li> <li>✓ Start button</li> </ul>	<ul style="list-style-type: none"> <li>✓ Battery charger</li> <li>✓ n.2 AA rechargeable batteries</li> <li>✓ Spare batteries</li> <li>✓ Receiver wired cable 2.5m</li> <li>✓ Protective plastic cover</li> <li>✓ Shoulder belt</li> <li>✓ Receiver fixing kit</li> <li>✓ Spare fuses</li> <li>✓ Dedicated package</li> </ul>	<ul style="list-style-type: none"> <li>✓ EC certificate</li> <li>✓ Test report</li> <li>✓ User's manual</li> <li>✓ Electric diagram</li> <li>✓ CD Rom</li> </ul>

 <b>Nova F24-8D-6</b>	Power supply	Main features	Standard equipment	Documentation
 <p>6 double speed + start + EMS</p> <p><b>Price: Euro 990,00</b> Twin: Euro 1305,00 <i>*with horn</i></p>	<ul style="list-style-type: none"> <li>✓ 12-24 V DC</li> <li>✓ 24-48-110 V AC</li> <li>✓ 48-110-220 V AC</li> <li>✓ 48-220-380 V AC</li> </ul>	<ul style="list-style-type: none"> <li>✓ 6 double speed buttons</li> <li>✓ Emergency stop class 3</li> <li>✓ Start button</li> <li>✓ Removable key</li> <li>✓ Horn included</li> <li>✓ External antenna optional</li> </ul>	<ul style="list-style-type: none"> <li>✓ Battery charger</li> <li>✓ n.2 AA rechargeable batteries</li> <li>✓ Spare batteries</li> <li>✓ Receiver wired cable 2.5m</li> <li>✓ Protective plastic cover</li> <li>✓ Shoulder belt</li> <li>✓ Receiver fixing kit</li> <li>✓ Spare fuses</li> <li>✓ Dedicated package</li> </ul>	<ul style="list-style-type: none"> <li>✓ EC certificate</li> <li>✓ Test report</li> <li>✓ User's manual</li> <li>✓ Electric diagram</li> <li>✓ CD Rom</li> </ul>

 <b>Magnum F23-8D-6</b>	Power supply	Main features	Standard equipment	Documentation
 <p>6 double speed + start + EMS</p> <p><b>Price: Euro 1005,00</b> Twin: Euro 1365,00</p>	<ul style="list-style-type: none"> <li>✓ 12-24 V DC</li> <li>✓ 24-48-110 V AC</li> <li>✓ 48-110-220 V AC</li> <li>✓ 48-220-380 V AC</li> </ul>	<ul style="list-style-type: none"> <li>✓ 6 double speed buttons</li> <li>✓ Emergency stop class 3</li> <li>✓ Start button</li> <li>✓ Larger receiver unit with easy connectors</li> <li>✓ Removable key</li> <li>✓ External antenna optional</li> </ul>	<ul style="list-style-type: none"> <li>✓ Battery charger</li> <li>✓ n.2 AA rechargeable batteries</li> <li>✓ Spare batteries</li> <li>✓ Receiver wired cable 2.5m</li> <li>✓ Protective plastic cover</li> <li>✓ Shoulder belt</li> <li>✓ Receiver fixing kit</li> <li>✓ Spare fuses</li> <li>✓ Dedicated package</li> </ul>	<ul style="list-style-type: none"> <li>✓ EC certificate</li> <li>✓ Test report</li> <li>✓ User's manual</li> <li>✓ Electric diagram</li> <li>✓ CD Rom</li> </ul>

 <b>Top F25-6D</b>	Power supply	Main features	Standard equipment	Documentation
 <p>6 double speed + start + horn + EMS</p> <p><b>Price: Euro 1155,00</b> Twin: Euro 1545,00</p>	<ul style="list-style-type: none"> <li>✓ 12-24 V DC</li> <li>✓ 24-48-110 V AC</li> <li>✓ 48-110-220 V AC</li> <li>✓ 48-220-380 V AC</li> </ul>	<ul style="list-style-type: none"> <li>✓ 6 double speed buttons</li> <li>✓ Emergenza classe 4</li> <li>✓ Trasmissione radio PLL</li> <li>✓ horn integrata</li> <li>✓ Start button</li> <li>✓ Removable key</li> <li>✓ External antenna optional</li> </ul>	<ul style="list-style-type: none"> <li>✓ Battery charger</li> <li>✓ N.4 AA rechargeable batteries</li> <li>✓ Spare batteries</li> <li>✓ Receiver wired cable 2.5m</li> <li>✓ Protective plastic cover</li> <li>✓ Shoulder belt</li> <li>✓ Receiver fixing kit</li> <li>✓ Spare fuses</li> <li>✓ Dedicated package</li> </ul>	<ul style="list-style-type: none"> <li>✓ EC certificate</li> <li>✓ Test report</li> <li>✓ User's manual</li> <li>✓ Electric diagram</li> <li>✓ CD Rom</li> </ul>

# 8 BUTTONS + START & STOP

## Tender F21-E2-8



8 singolavelocità + start + EMS

**Price: Euro 530,00**

*Twin: Euro 690,00*

### Power supply

- ✓ 12-24 V DC
- ✓ 24-48 V AC
- ✓ 48-110 V AC
- ✓ 48-220 V AC

### Main features

- ✓ 8 single speed buttons
- ✓ Chiave di start estraibile
- ✓ E-Card
- ✓ Copier function

### Standard equipment

- ✓ n.2 batteries AA
- ✓ Receiver wired cable 1.5m
- ✓ Protective plastic cover
- ✓ Shoulder belt
- ✓ Spare fuses
- ✓ Dedicated package

### Documentation

- ✓ EC certificate
- ✓ Test report
- ✓ User's manual
- ✓ Electric diagram
- ✓ CD Rom

## Nova F24-8S



8 single speed + start + EMS

**Price: € 790,00**

*Twin: € 1045,00*

### Power supply

- ✓ 12-24 V DC
- ✓ 24-48-110 V AC
- ✓ 48-110-220 V AC
- ✓ 48-220-380 V AC

### Main features

- ✓ 6 single speed buttons
- ✓ Emergency stop class 3
- ✓ Start button
- ✓ Removable key
- ✓ External antenna optional

### Standard equipment

- ✓ Battery charger
- ✓ n.2 AA rechargeable batteries
- ✓ Spare batteries
- ✓ Receiver wired cable 2.5m
- ✓ Protective plastic cover
- ✓ Shoulder belt
- ✓ Receiver fixing kit
- ✓ Spare fuses
- ✓ Dedicated package

### Documentation

- ✓ EC certificate
- ✓ Test report
- ✓ User's manual
- ✓ Electric diagram
- ✓ CD Rom

## Magnum F23-8D-8



8 double speed + start + EMS

**Price: Euro 1025,00**

*Twin: Euro 1365,00*

### Power supply

- ✓ 12-24 V DC
- ✓ 24-48-110 V AC
- ✓ 48-110-220 V AC
- ✓ 48-220-380 V AC

### Main features

- ✓ 8 double speed buttons
- ✓ Emergency stop class 3
- ✓ Start button
- ✓ Removable key
- ✓ External antenna optional

### Standard equipment

- ✓ Battery charger
- ✓ n.2 AA rechargeable batteries
- ✓ Spare batteries
- ✓ Receiver wired cable 2.5m
- ✓ Protective plastic cover
- ✓ Shoulder belt
- ✓ Receiver fixing kit
- ✓ Spare fuses
- ✓ Dedicated package

### Documentation

- ✓ EC certificate
- ✓ Test report
- ✓ User's manual
- ✓ Electric diagram
- ✓ CD Rom

## Top F25-8D



8 double speed + horn + start + EMS

**Price: Euro 1210,00**

*Twin: Euro 1605,00*

### Power supply

- ✓ 12-24 V DC
- ✓ 24-48-110 V AC
- ✓ 48-110-220 V AC
- ✓ 48-220-380 V AC

### Main features

- ✓ 8 double speed buttons
- ✓ Emergency stop class 4
- ✓ PLL radio transmission system
- ✓ Integrated horn
- ✓ Start button
- ✓ Removable key
- ✓ External antenna optional

### Standard equipment

- ✓ Battery charger
- ✓ N.4 AA rechargeable batteries
- ✓ Spare batteries
- ✓ Receiver wired cable 2.5m
- ✓ Protective plastic cover
- ✓ Shoulder belt
- ✓ Receiver fixing kit
- ✓ Spare fuses
- ✓ Dedicated package

### Documentation

- ✓ EC certificate
- ✓ Test report
- ✓ User's manual
- ✓ Electric diagram
- ✓ CD Rom

# 10/12 BUTTONS + START & STOP

Nova F24-10S	Power supply	Main features	Standard equipment	Documentation
 <p>10 single speed + start + EMS</p> <p><b>Price: € 825,00</b> <i>Twin: € 1100,00</i></p>	<ul style="list-style-type: none"> <li>✓ 12-24 V DC</li> <li>✓ 24-48-110 V AC</li> <li>✓ 48-110-220 V AC</li> <li>✓ 48-220-380 V AC</li> </ul>	<ul style="list-style-type: none"> <li>✓ 10 single speed buttons</li> <li>✓ Emergency stop class 3</li> <li>✓ Start button</li> <li>✓ Removable key</li> <li>✓ External antenna optional</li> </ul>	<ul style="list-style-type: none"> <li>✓ Battery charger</li> <li>✓ n.2 AA rechargeable batteries</li> <li>✓ Spare batteries</li> <li>✓ Receiver wired cable 2.5m</li> <li>✓ Protective plastic cover</li> <li>✓ Shoulder belt</li> <li>✓ Receiver fixing kit</li> <li>✓ Spare fuses</li> <li>✓ Dedicated package</li> </ul>	<ul style="list-style-type: none"> <li>✓ EC certificate</li> <li>✓ Test report</li> <li>✓ User's manual</li> <li>✓ Electric diagram</li> <li>✓ CD Rom</li> </ul>

Magnum F23-8D-10	Power supply	Main features	Standard equipment	Documentation
 <p>10 double speed + start + EMS</p> <p><b>Price: € 1070,00</b> <i>Twin: € 1440,00</i></p>	<ul style="list-style-type: none"> <li>✓ 12-24 V DC</li> <li>✓ 24-48-110 V AC</li> <li>✓ 48-110-220 V AC</li> <li>✓ 48-220-380 V AC</li> </ul>	<ul style="list-style-type: none"> <li>✓ 10 double speed buttons</li> <li>✓ Emergency stop class 3</li> <li>✓ Start button</li> <li>✓ Removable key</li> <li>✓ External antenna optional</li> </ul>	<ul style="list-style-type: none"> <li>✓ Battery charger</li> <li>✓ n.2 AA rechargeable batteries</li> <li>✓ Spare batteries</li> <li>✓ Receiver wired cable 2.5m</li> <li>✓ Protective plastic cover</li> <li>✓ Shoulder belt</li> <li>✓ Receiver fixing kit</li> <li>✓ Spare fuses</li> <li>✓ Dedicated package</li> </ul>	<ul style="list-style-type: none"> <li>✓ EC certificate</li> <li>✓ Test report</li> <li>✓ User's manual</li> <li>✓ Electric diagram</li> <li>✓ CD Rom</li> </ul>

Top F25-10D	Power supply	Main features	Standard equipment	Documentation
 <p>10 double speed + horn + start + EMS</p> <p><b>Price: Euro 1265,00</b> <i>Twin: Euro 1655,00</i></p>	<ul style="list-style-type: none"> <li>✓ 12-24 V DC</li> <li>✓ 24-48-110 V AC</li> <li>✓ 48-110-220 V AC</li> <li>✓ 48-220-380 V AC</li> </ul>	<ul style="list-style-type: none"> <li>✓ 10 double speed buttons</li> <li>✓ Emergency stop class 4</li> <li>✓ PLL radio transmission system</li> <li>✓ Integrated horn</li> <li>✓ Start button</li> <li>✓ Removable key</li> <li>✓ External antenna optional</li> </ul>	<ul style="list-style-type: none"> <li>✓ Battery charger</li> <li>✓ N.4 AA rechargeable batteries</li> <li>✓ Spare batteries</li> <li>✓ Receiver wired cable 2.5m</li> <li>✓ Protective plastic cover</li> <li>✓ Shoulder belt</li> <li>✓ Receiver fixing kit</li> <li>✓ Spare fuses</li> <li>✓ Dedicated package</li> </ul>	<ul style="list-style-type: none"> <li>✓ EC certificate</li> <li>✓ Test report</li> <li>✓ User's manual</li> <li>✓ Electric diagram</li> <li>✓ CD Rom</li> </ul>

Nova F24-12D	Power supply	Main features	Standard equipment	Documentation
 <p>12 double speed + start + EMS</p> <p><b>Price: Euro 1100,00</b> <i>Twin: Euro 1485,00</i></p>	<ul style="list-style-type: none"> <li>✓ 12-24 V DC</li> <li>✓ 24-48-110 V AC</li> <li>✓ 48-110-220 V AC</li> <li>✓ 48-220-380 V AC</li> </ul>	<ul style="list-style-type: none"> <li>✓ 12 double speed buttons</li> <li>✓ Emergency stop class 3</li> <li>✓ Start button</li> <li>✓ Removable key</li> <li>✓ External antenna optional</li> </ul>	<ul style="list-style-type: none"> <li>✓ Battery charger</li> <li>✓ n.2 AA rechargeable batteries</li> <li>✓ Spare batteries</li> <li>✓ Receiver wired cable 2.5m</li> <li>✓ Protective plastic cover</li> <li>✓ Shoulder belt</li> <li>✓ Receiver fixing kit</li> <li>✓ Spare fuses</li> <li>✓ Dedicated package</li> </ul>	<ul style="list-style-type: none"> <li>✓ EC certificate</li> <li>✓ Test report</li> <li>✓ User's manual</li> <li>✓ Electric diagram</li> <li>✓ CD Rom</li> </ul>



# JOYSTICK

## Easy F24-60E PLL



2 joystick 3 speeds+ 1 function button+ 2 selectors + start + EMS

**Price: Euro 1455,00**

*Twin: Euro 2195,00*

### Power supply

- ✓ 12-24 V DC
- ✓ 24-48 V AC
- ✓ 48-110 V AC
- ✓ 48-220 V AC

### Technical features

- ✓ 2 joysticks 3 speeds + 1 function button + 2 selectors + start and stop
- ✓ Emergency stop class 3
- ✓ Removable key
- ✓ Start button
- ✓ External antenna optional
- ✓ PLL model

### Standard equipment

- ✓ Battery charger
- ✓ n.4 AA rechargeable batteries
- ✓ Spare batteries
- ✓ Receiver wired cable 2.5m
- ✓ Protective plastic cover
- ✓ Shoulder belt
- ✓ Rubber protection
- ✓ Receiver fixing kit
- ✓ Spare fuses
- ✓ Dedicated package

### Documentation

- ✓ EC certificate
- ✓ Test report
- ✓ User's manual
- ✓ Electric diagram
- ✓ CD Rom

## Joy F24-60 PLL



2 joystick 5 speeds + 4 function buttons + 4 selectors + start + EMS

**Price: Euro 1645,00**

*Twin: Euro 2560,00*

### Power supply

- ✓ 12-24 V DC
- ✓ 24-48 V AC
- ✓ 48-110 V AC
- ✓ 48-220 V AC

### Technical features

- ✓ 2 joysticks 5 speeds + 4 function button + 4 selectors + start and stop
- ✓ Emergency stop class 3
- ✓ Removable key
- ✓ Start button
- ✓ External antenna optional
- ✓ PLL model

### Standard equipment

- ✓ Battery charger
- ✓ n.4 AA rechargeable batteries
- ✓ Spare batteries
- ✓ Receiver wired cable 2.5m
- ✓ Protective plastic cover
- ✓ Shoulder belt
- ✓ Rubber protection
- ✓ Receiver fixing kit
- ✓ Spare fuses
- ✓ Dedicated package

### Documentation

- ✓ EC certificate
- ✓ Test report
- ✓ User's manual
- ✓ Electric diagram
- ✓ CD Rom



**TELECRANE ITALIA SRL**

Via G. Rossa, 8 - 20024 Garbagnate M.se (MI) Italy

+39 02 9958665 [info@telecrane.it](mailto:info@telecrane.it)

[www.telecrane.it](http://www.telecrane.it)